

Online Learning Lessons for *Couch's Class*

Directions: Please complete the following work below for each subject. This work will count toward your final grade and must be complete to get credit for attendance.

Student Name _____

DATE: 4/23/20

ELA

FINISH

Google Classroom:
Reading Comprehension-The Hummingbird

Parent Initials: _____

Math

Google Classroom:
Measuring Temperature, Fahrenheit and Celsius

Parent Initials: _____

Science

FINISH

Google Classroom:
Earth Day Lesson! Interactive Slides on the 3R's

Parent Initials: _____

History/Social Studies

No Social Studies Today!

Parent Initials: _____

Parent Signature: _____

If you have questions, please email me. Thank you!

Ms. Couch

scouch@mcusd1.net

Teacher Hours:
9:00 am - 11:30 am
12:30 pm - 2:30 pm

Reading a Thermometer

Directions: Write the temperature in °C

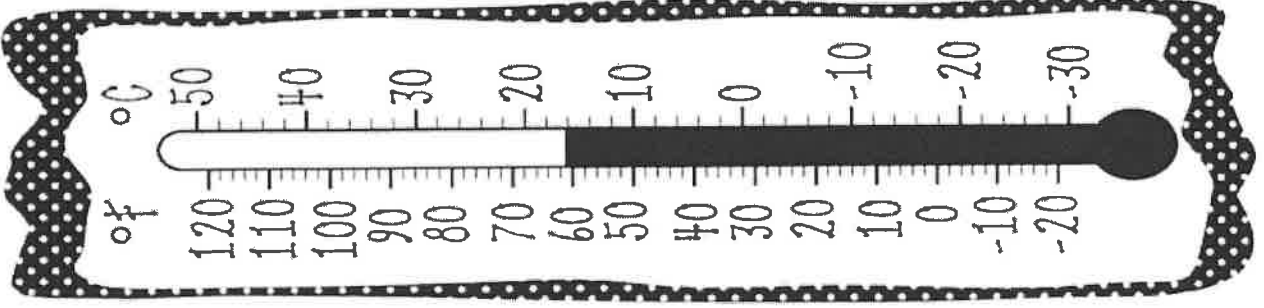
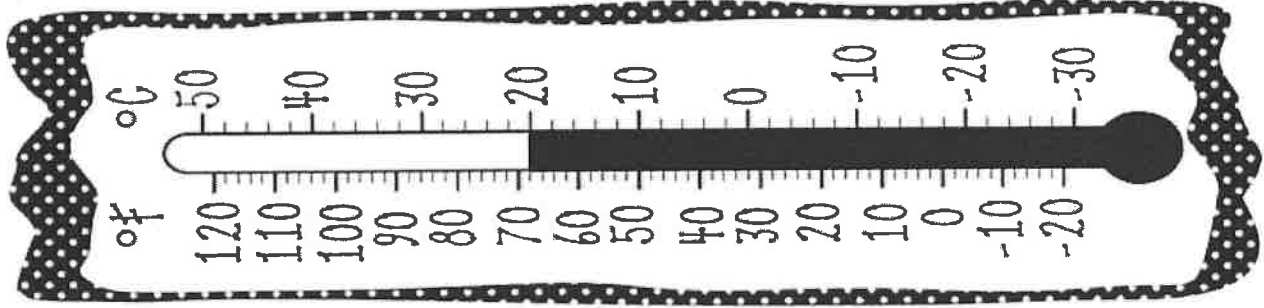
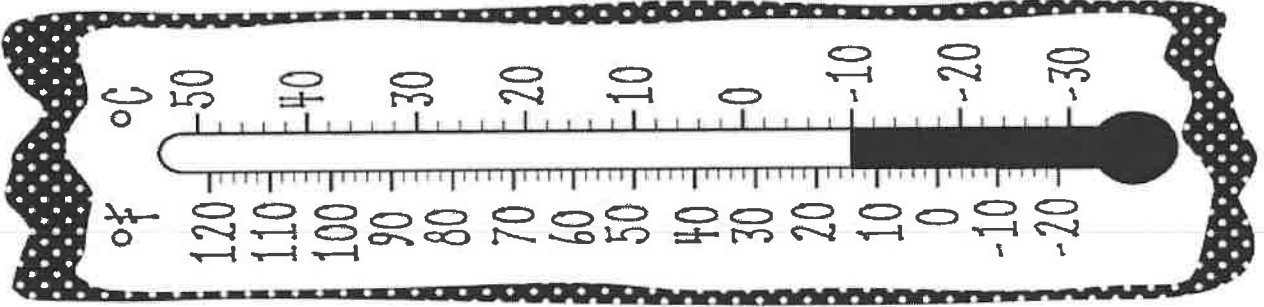
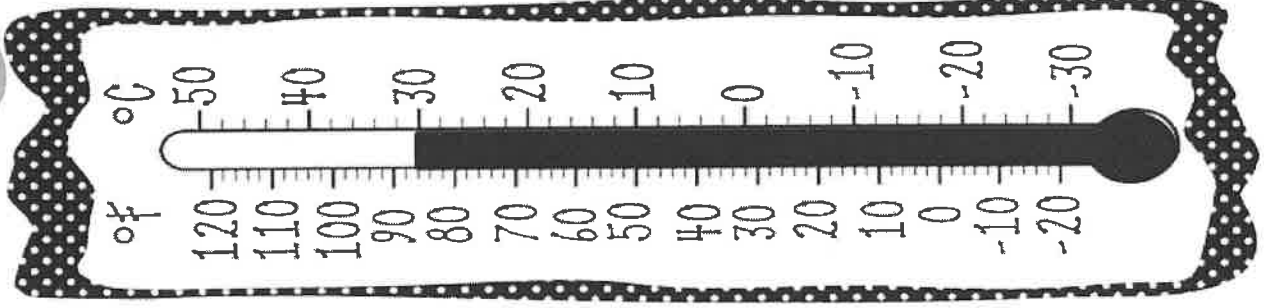
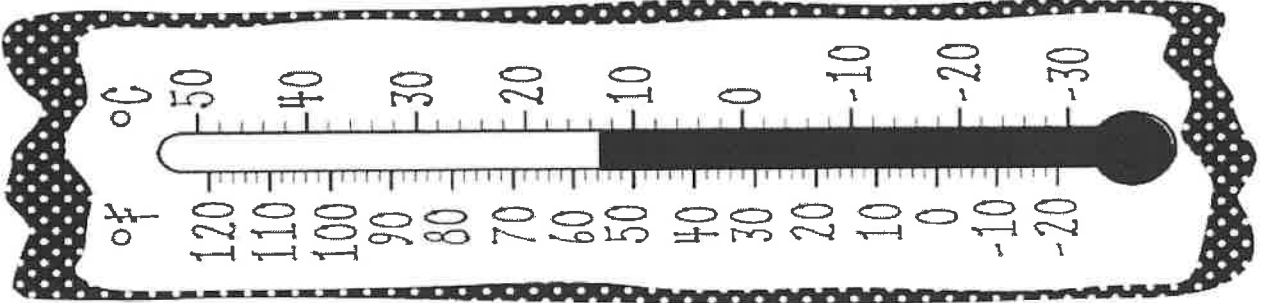

Directions: Write the temperature in °F

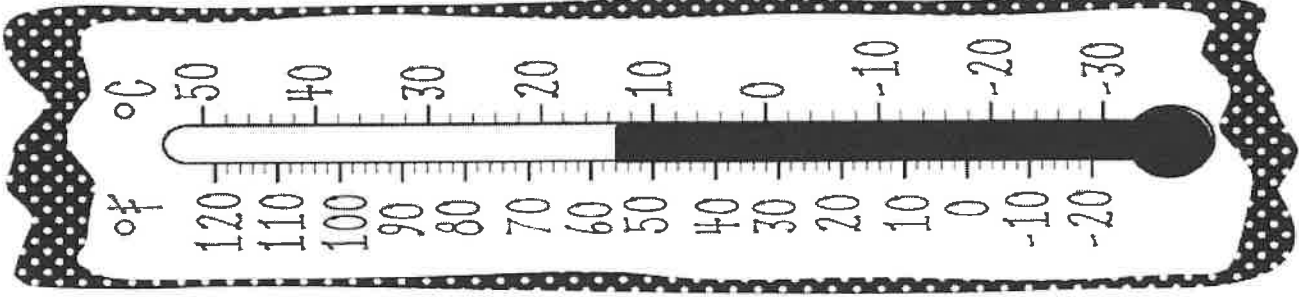

6. 56 °F

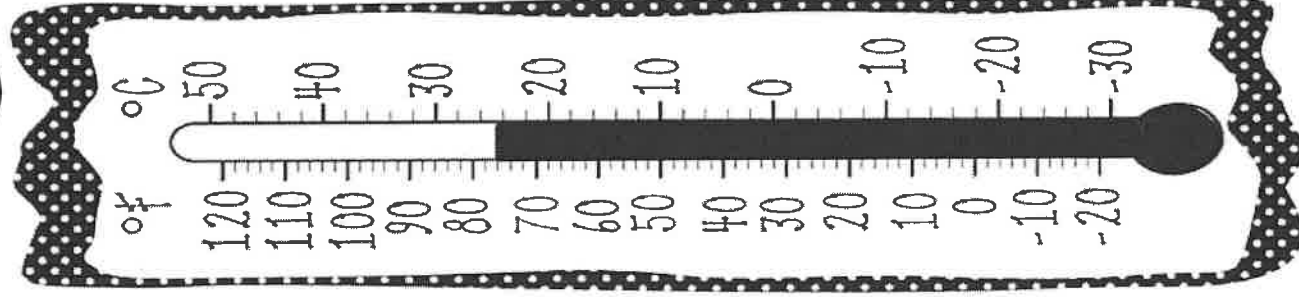

7.

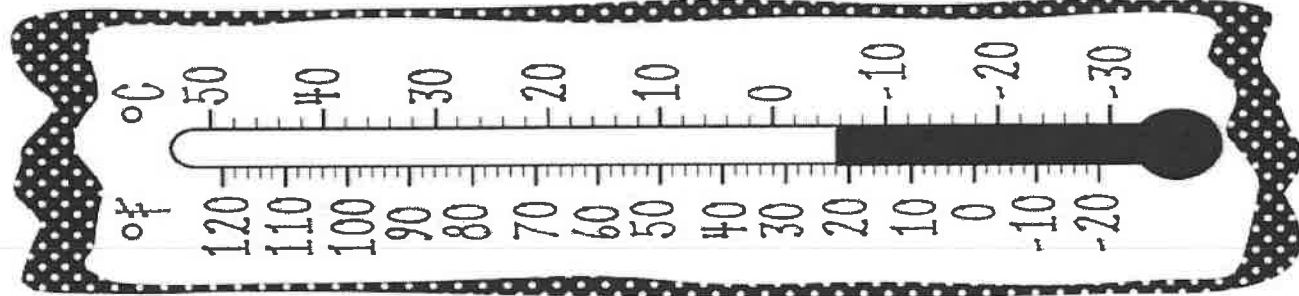

8.

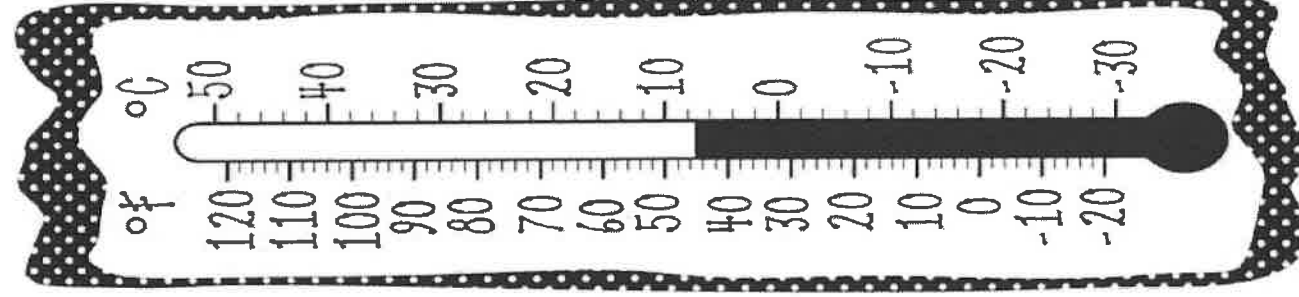

9.

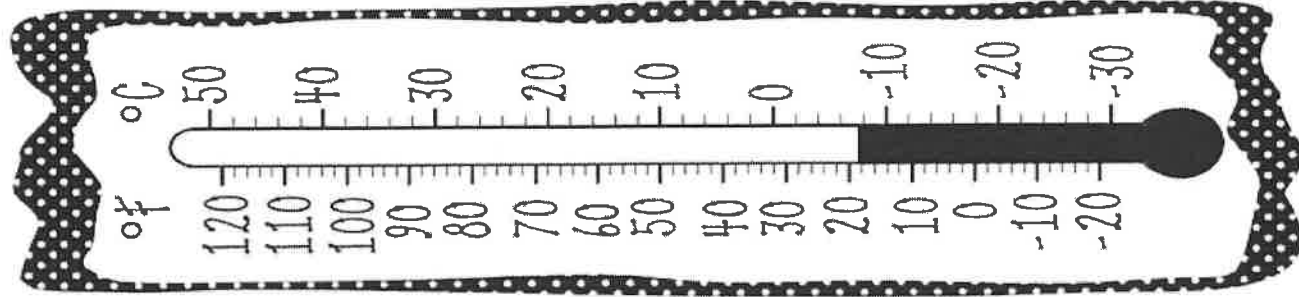

10.

LET'S DO SCIENCE!

YOUR JOB:

1. Watch the three videos
2. Read the passage and answer the questions
3. Write about what you have learned
4. Sort the 3 R's and write your own examples

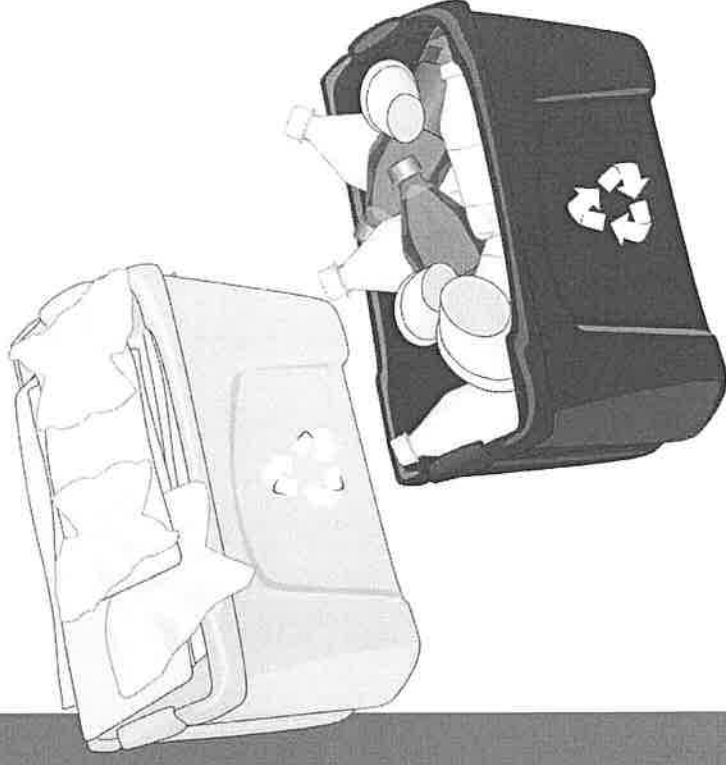

WATCH A VIDEO ABOUT RECYCLING

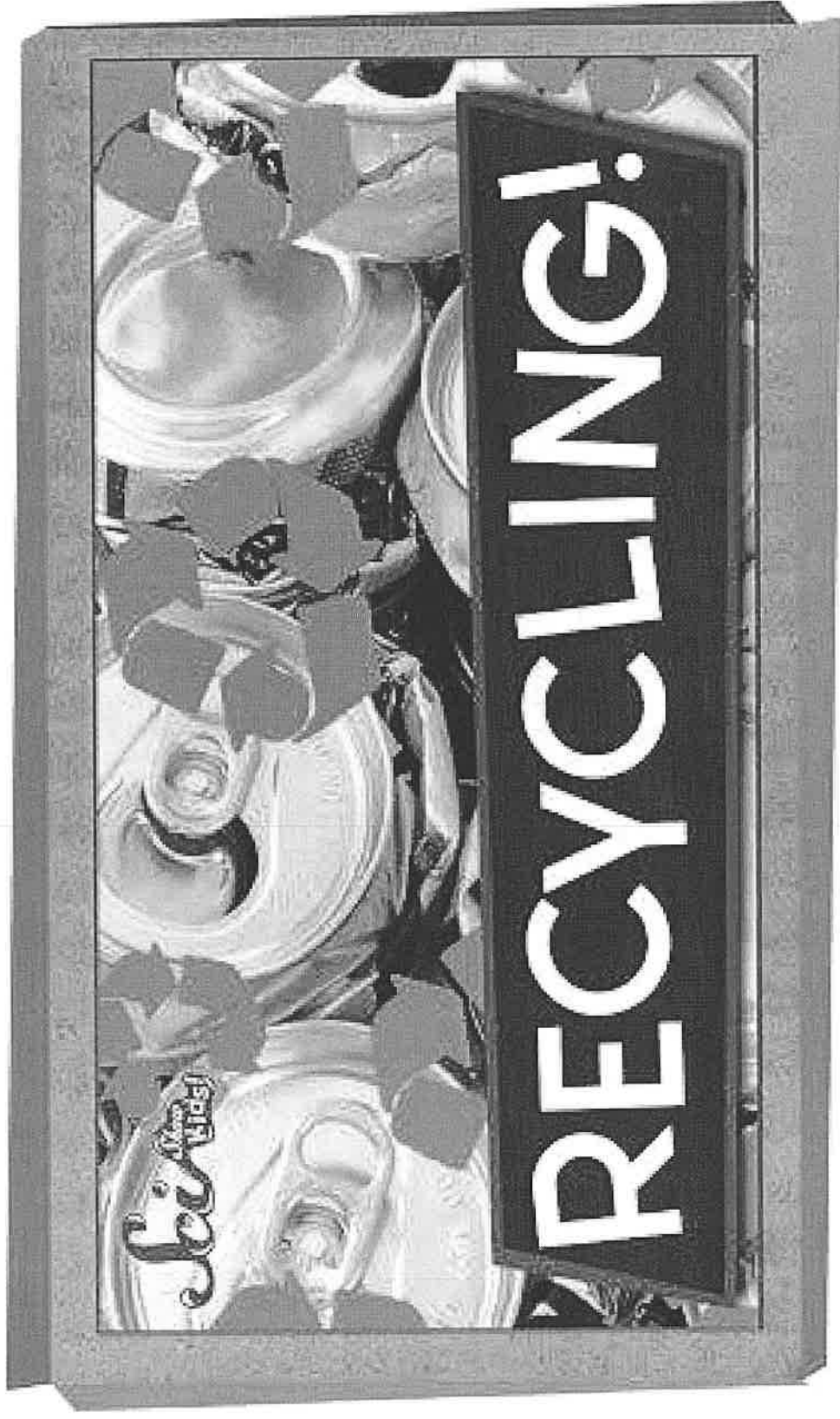

WATCH A VIDEO ABOUT PLASTIC

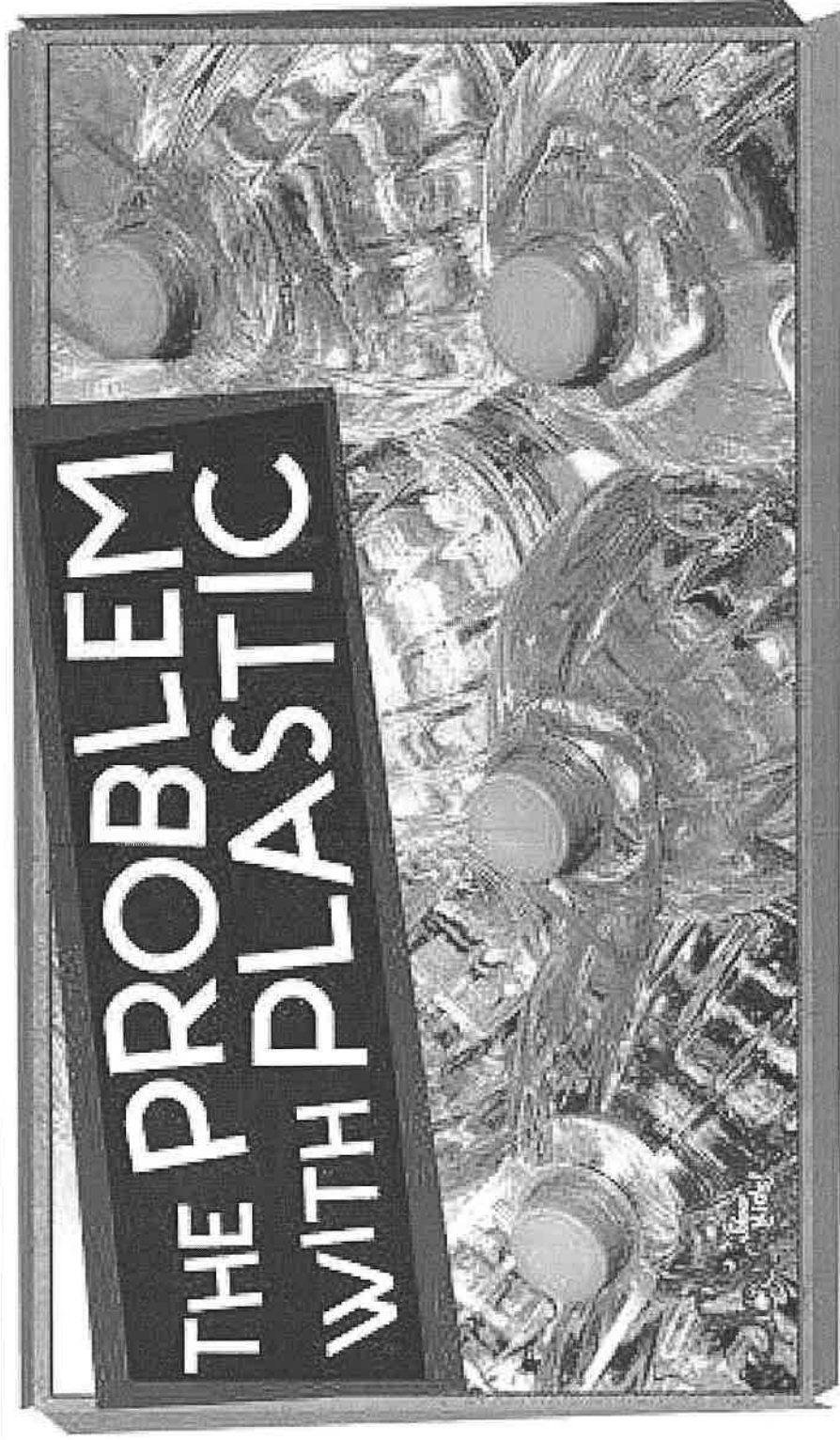

WATCH A VIDEO ABOUT COMPOSTING

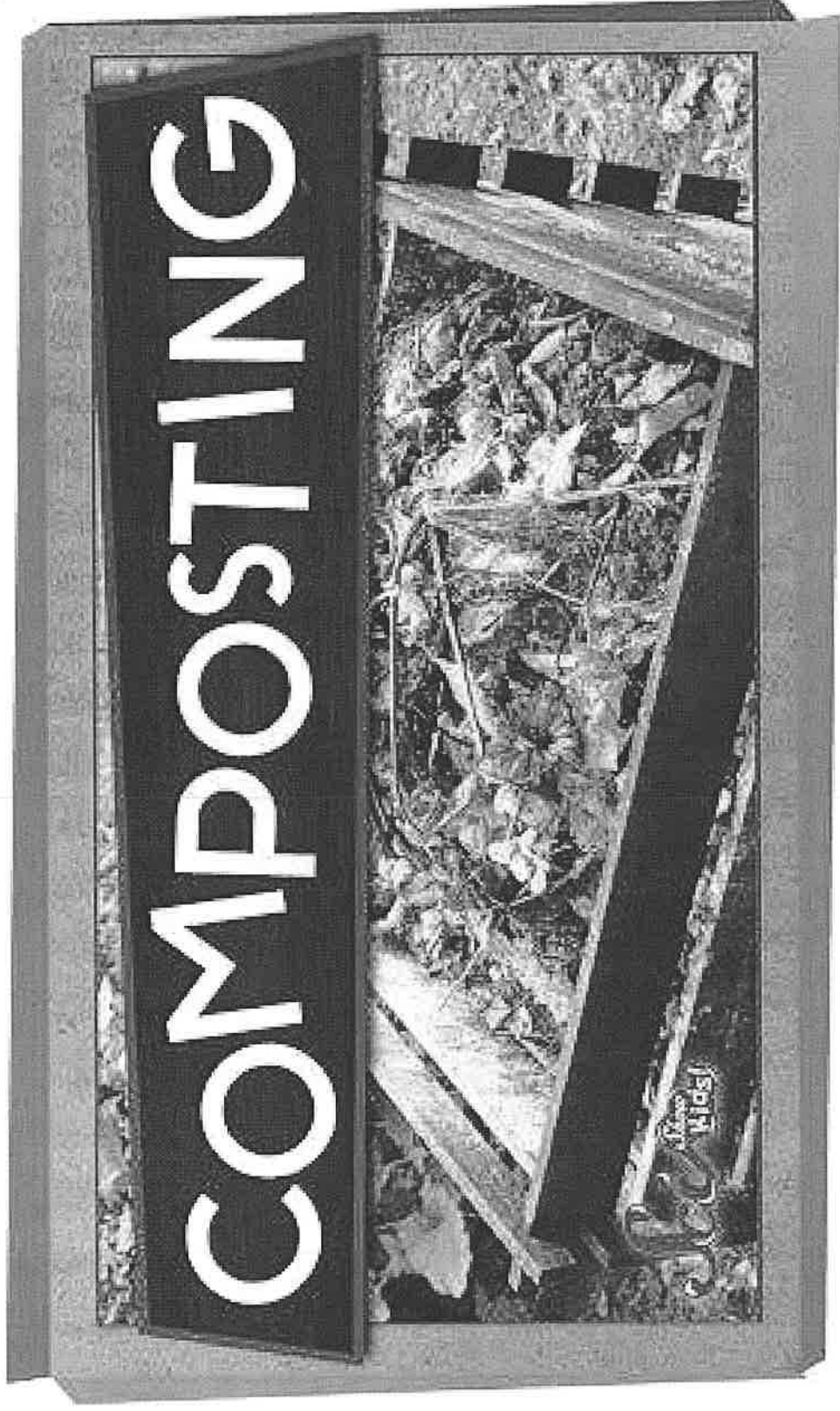

Read the paragraphs below. Then, answer the questions. Move the circles over your answer choices.

Earth Day is a day we celebrate the Earth each year. It was created to promote **awareness** about our planet's environment. Senator Nelson from Wisconsin was the founder of Earth Day. Each year, on April 22nd, people all over the world celebrate Earth Day.

Earth Day is a time for people to come together to help care for our Earth. It is important for people to think about things like pollution, deforestation, and recycling.

There are things you can do to help the Earth. Always use a trash can or a recycling can and never litter. If you see litter, pick it up and put it where it belongs. You can also help the Earth by planting trees. Many communities have tree planting events on Earth Day.

Another way you can help the Earth is by not wasting water. Turn the water off when you are not using it. You can also help our planet by turning off the lights, and unplugging things you are not using. Electricity comes from fossil fuels, like coal, oil, or gas. Turning off and unplugging things we are not using can help us not waste these resources.

1. What is the main idea of the third paragraph?
 - a. What Earth Day is
 - b. Who founded Earth Day
 - c. Things you can do to help the Earth
2. What is the meaning of the word **awareness**?
 - a. to think about
 - b. to ignore
 - c. to decide
3. Why is it important to turn off and unplug things we aren't using?
 - a. to save fossil fuels
 - b. to stay warm
 - c. to keep the planet darker

How can you help the Earth? You can use details from the text and video you watched in your answer.

Earth Day is a day we celebrate the Earth each year. It was created to promote awareness about our planet's environment. Senator Nelson from Wisconsin was the founder of Earth Day. Each year, on April 22nd, people all over the world celebrate Earth Day.

Earth Day is a time for people to come together to help care for our Earth. It is important for people to think about things like pollution, deforestation, and recycling.

There are things you can do to help the Earth. Always use a trash can or a recycling can and never litter. If you see litter, pick it up and put it where it belongs. You can also help the Earth by planting trees. Many communities have tree planting events on Earth Day. Another way you can help the Earth is by not wasting water. Turn the water off when you are not using it. You can also help our planet by turning off the lights, and unplugging things you are not using. Electricity comes from fossil fuels, like coal, oil, or gas. Turning off and unplugging things we are not using can help us not waste these resources.

(You need 5 bullet points)

To help the earth, I can:



SORT THE THREE R'S

REDUCE

to use less of something

Use glass plates instead of paper plates

Example: Turn off the light switches in the house when you are not using those rooms

REUSE

to use something again, to find another way to use something

To donate clothes that don't fit you

Type your own example of reusing here

RECYCLE

to turn into something else

Type your own example of recycling here